



Cisco 6015 Fan Module FRU Installation and Replacement Notes

Product Number: 6015-FM-01=

This document provides an overview of and installation and replacement procedures for the Cisco 6015 fan module. The fan module is a field-replaceable unit (FRU).



Warning

Only trained and qualified personnel should be allowed to install, replace, or service this equipment.

Contents

This document includes the following sections:

- [Introduction, page 2](#)
- [Part and Tool Requirements, page 5](#)
- [General Safety Precautions and Maintenance Guidelines, page 6](#)
- [Removing and Installing the Fan Module, page 12](#)
- [Standards and Certifications, page 13](#)
- [Related Documentation, page 14](#)
- [Obtaining Documentation, page 14](#)
- [Obtaining Technical Assistance, page 15](#)



Corporate Headquarters:
Cisco Systems, Inc., 170 West Tasman Drive, San Jose, CA 95134-1706 USA

Copyright © 2002. Cisco Systems, Inc. All rights reserved.

Introduction

Figure 1 shows the location of the fan module in the Cisco 6015 chassis.

Figure 1 Fan Module Location in the Cisco 6015 Chassis

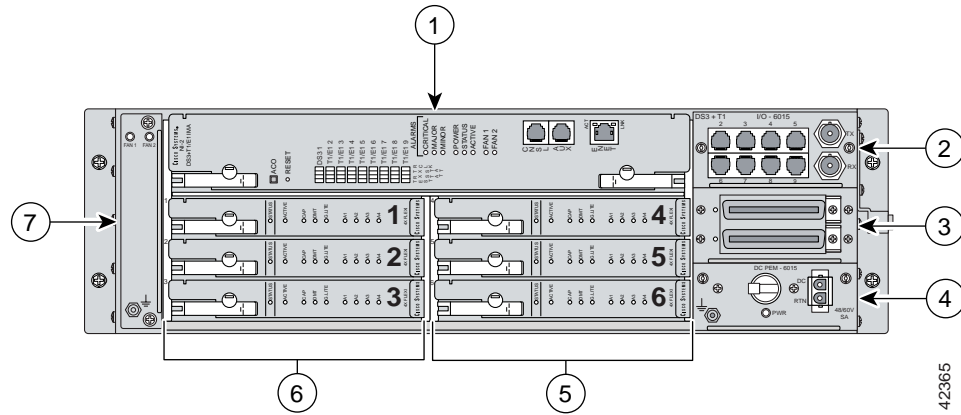

1	NI-2 card	5	xDSL line cards (slots 4 to 6)
2	I/O ¹ module	6	xDSL line cards (slots 1 to 3)
3	DSL ² interface module	7	Fan module
4	DC PEM ³		

1. I/O = input/output
2. DSL = digital subscriber line
3. PEM = power entry module

The fan module houses two fans that provide system cooling. The Cisco 6015 requires that a fan module be installed when the system is in operation. [Figure 2](#) shows the fan module.

Figure 2 Fan Module for the Cisco 6015

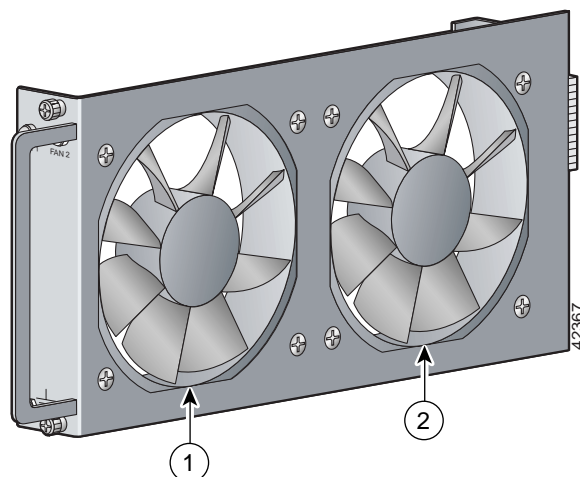

1	Fan 2	2	Fan 1
---	-------	---	-------



Note

The fan module is installed in the chassis when it is shipped. If the fan module fails, replace it immediately.

Figure 3 shows a close-up of the fan module faceplate.

Figure 3 Fan Module Faceplate

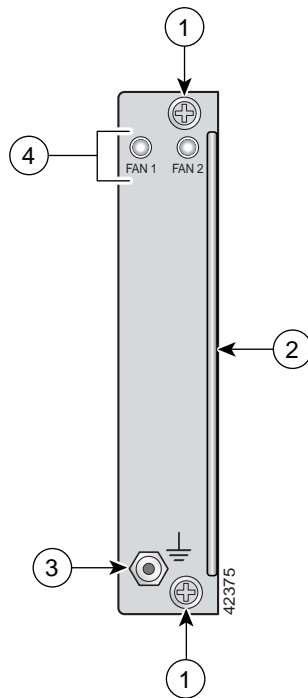

1	Screws to secure the fan module to the chassis.	3	ESD grounding jack.
2	Extraction handle.	4	Fan LEDs. The LED on the left is for the fan that is located closest to the back of the chassis (Fan 1). The LED on the right is for the fan that is located closest to the front of the chassis (Fan 2).

If the fan LEDs are

- Green—The fan is operational.
- Red—The fan is not operational and the fan module is in alarm mode. Refer to the *Cisco 6015 Hardware Installation Guide* for troubleshooting procedures.
- Off—The fan is not operational due to a power problem or the LED is defective. Refer to the *Cisco 6015 Hardware Installation Guide* for troubleshooting procedures.

The fan module pulls air from the right of the chassis, through the modules, and out the left of the chassis, as shown in [Figure 4](#).

Figure 4 Air Flow Through Intake and Exhaust Vents on the Chassis

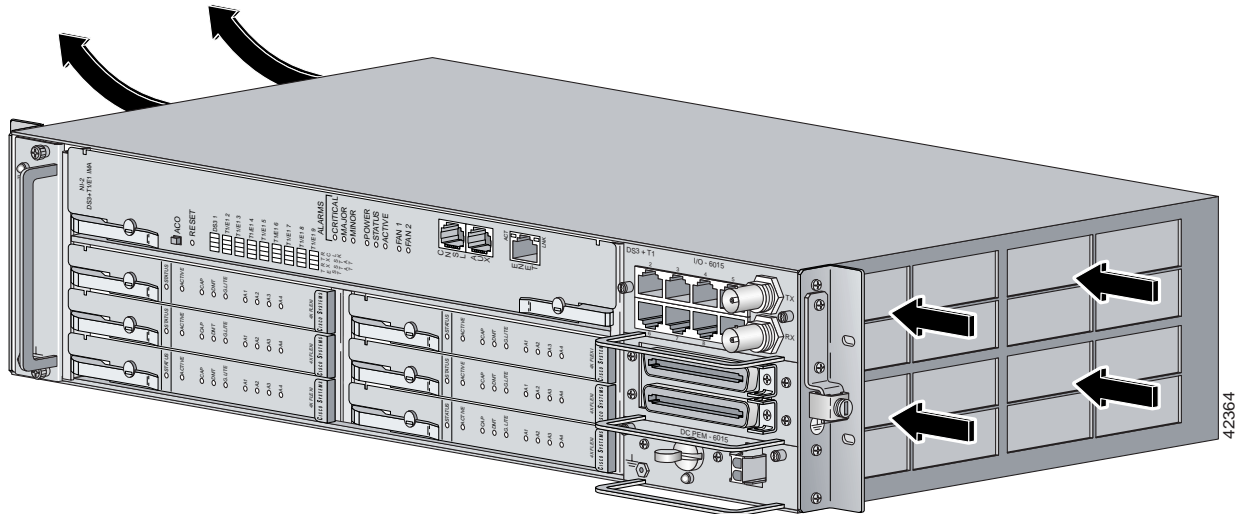

[Table 1](#) lists the specifications for the fan module.

Table 1 Fan Module Specifications

Specification	Description
Dimensions	Height: 5.0 in. (12.7 cm) Depth: 9.375 in. (23.813 cm) Width: 1.125 in. (2.86 cm)
Weight	0.87 lb (0.40 kg)
Power consumption	9W
Minimum software and network management requirement	Cisco IOS—Release 12.1(4)DA CDM ¹ —Release 3.2

1. CDM = Cisco DSL Manager

Part and Tool Requirements

[Table 2](#) lists the tools and equipment that you need to install and remove a fan module.

Table 2 Tool and Equipment Requirements Checklist

Check	Tools and Equipment
	Fan module.
	Equipment necessary for ESD protection—You need this equipment whenever you handle Cisco chassis, modules, and cards.

Table 2 Tool and Equipment Requirements Checklist (continued)

Check	Tools and Equipment
	No. 1 Phillips-head or flat-head screwdriver
	Cisco IOS or CDM
	Note See Table 1 for minimum software and network management release requirements.

General Safety Precautions and Maintenance Guidelines

This section describes the following areas:

- [General Safety Precautions, page 6](#)
- [General Maintenance Guidelines, page 10](#)
- [Preventing Electrostatic Discharge Damage, page 11](#)

General Safety Precautions

Before working on the equipment, be aware of standard safety guidelines and the hazards involved in working with electrical circuitry to prevent accidents. Adhere to the following cautions and warnings and those throughout the guide for safe and hazard-free installation.



Note

To see translations of the warnings that appear in this publication, refer to the *Regulatory Compliance and Safety Information for the Cisco 6015 System* document that accompanied this product.



Caution

Before you start the installation procedures, read the entire document for important information and safety warnings.



Caution

Proper ESD protection is required whenever you handle Cisco equipment. Installation and maintenance personnel should be properly grounded by means of grounding straps to eliminate the risk of ESD damage to the equipment. Equipment is subject to ESD damage whenever it is removed from the chassis.



Caution

If the power connections are improperly connected and power is applied while the cards are installed, the cards and chassis could be damaged.



Caution

It is important that the chassis cooling fans run continuously while the system is powered.



Caution

Any card that is only partially connected to the backplane can disrupt system operation.



Warning

This warning symbol means *danger*. You are in a situation that could cause bodily injury. Before you work on any equipment, be aware of the hazards involved with electrical circuitry and be familiar with standard practices for preventing accidents.



Warning

This unit is intended for installation in restricted access areas. A restricted access area is where access can only be gained by service personnel through the use of a special tool, lock and key, or other means of security, and is controlled by the authority responsible for the location.



Warning

Only trained and qualified personnel should be allowed to install, replace, or service this equipment.



Warning

To prevent personal injury or damage to the chassis, never attempt to lift or tilt the chassis using the handles on the port adapters; these types of handles are not designed to support the weight of the unit. Lift the unit only by grasping the chassis underneath its lower edge.



Warning

Never attempt to lift the chassis with the handles on the power supplies or the switching modules. These handles are not designed to support the weight of the chassis. Using them to lift or support the chassis can result in severe damage to the equipment and serious bodily injury.



Warning

To prevent bodily injury when mounting or servicing this unit in a rack, you must take special precautions to ensure that the system remains stable. The following guidelines are provided to ensure your safety:

—This unit should be mounted at the bottom of the rack if it is the only unit in the rack.

—When mounting this unit in a partially filled rack, load the rack from the bottom to the top with the heaviest component at the bottom of the rack.

—If the rack is provided with stabilizing devices, install the stabilizers before mounting or servicing the unit in the rack.



Warning

Removing I/O cards, CPU cards, fans, and power supplies can expose you to high-energy (high-amperage) circuits and possible ejection of molten metal or to the shock hazard of telephony circuit voltages. Be sure to remove all rings, watches, and other jewelry from fingers, wrists, and arms before removing panels and devices.



Warning

Use extreme care when removing or installing connectors so that you do not damage them.



Warning

You are in a situation that could cause bodily injury. Before you work on any equipment, be aware of the hazards involved with electrical circuitry and be familiar with standard practices for preventing accidents.



Warning

Do not reach into a vacant slot or chassis while you install or remove a card, a module, or a fan. Exposed circuitry could constitute an energy hazard.



Warning

Never defeat the ground conductor or operate the equipment in the absence of a suitably installed ground conductor. Contact the appropriate electrical inspection authority or an electrician if you are uncertain that suitable grounding is available.



Warning

When installing the unit, the ground connection must always be made first and disconnected last.



Warning

For personal safety, the ground wire must connect to safety (earth) ground at both the equipment and supply side of the DC wiring (unless the local electrical code requirements are different).



Warning

This equipment needs to be grounded. Use a green and yellow 12 to 14 AWG ground wire to connect the host to earth ground during normal use.



Warning

Incorrect connection of this or connected equipment to a general purpose outlet could result in a hazardous situation.



Warning

Read the installation instructions before you connect the system to its power source.



Warning

Do not work on the system or connect or disconnect cables during periods of lightning activity.



Warning

To prevent the switch from overheating, do not operate it in an area that exceeds the maximum recommended ambient temperature of 104 F (40 C). To prevent airflow restriction, allow at least 3 inches (7.6 cm) of clearance around the ventilation openings.



Warning

Before working on a system that has an on/off switch, turn OFF the power and unplug the power cord.





Warning

This equipment will be inoperable when main power fails.



Warning

The power supply circuitry for the equipment can constitute an energy hazard. Before you install or replace the equipment, remove all jewelry (including rings, necklaces, and watches). Metal objects can come into contact with exposed power supply wiring or circuitry inside the equipment. This could cause the metal objects to heat up and cause serious burns or weld the metal object to the equipment.

-  **Warning** Before working on a chassis or working near power supplies, unplug the power cord on AC units; disconnect the power at the circuit breaker on DC units.
-  **Warning** Do not touch the power supply when the power cord is connected. For systems with a power switch, line voltages are present within the power supply even when the power switch is off and the power cord is connected. For systems without a power switch, line voltages are present within the power supply when the power cord is connected.
-  **Warning** Ultimate disposal of this product should be handled according to all national laws and regulations.
-  **Warning** This chassis must be installed in a rack that is secured to the building structure.
-  **Warning** Make sure that your equipment rack is properly ventilated.
-  **Warning** Connect the unit only to a DC power source that complies with the Safety Extra-Low Voltage (SELV) requirements in IEC 60950 based safety standards.
-  **Warning** This equipment is to be installed and maintained by service personnel only as defined by AS/NZS 3260 Clause 1.2.14.3 Service Personnel.
-  **Warning** This product requires short-circuit (overcurrent) protection, to be provided as part of the building installation. Install only in accordance with national and local wiring regulations.
-  **Warning** Care must be given to connecting units to the supply circuit so that wiring is not overloaded.
-  **Warning** VCCI Compliance for Class B Equipment (Japan).
- This is a Class B product based on the standard of the Voluntary Control Council for Interference from Information Technology Equipment (VCCI). If this is used near a radio or television receiver in a domestic environment, it may cause radio interference. Install and use the equipment according to the instruction manual.
-  **Warning** A voltage mismatch can cause equipment damage and may pose a fire hazard. If the voltage indicated on the label is different from the power outlet voltage, *do not connect the chassis to that receptacle.*



Warning

During line card installation, wear grounding wrist straps to avoid ESD damage to the card. Do not directly touch the backplane with your hand or any metal tool, or you could shock yourself.



Warning

An exposed wire lead from a DC-input power source can conduct harmful levels of electricity. Be sure that no exposed portion of the DC-input power source wire extends from the terminal block plug.



Warning

This equipment is intended to be grounded. Ensure that the host is connected to earth ground during normal use.



Warning

Metal objects heat up when connected to power and ground, and can cause serious burns.

General Maintenance Guidelines

This section covers the following topics:

- [Installation and Replacement Suggestions, page 10](#)
- [Hot Swapping Modules, page 10](#)

Installation and Replacement Suggestions

The following examples list recommended installation and replacement practices for the Cisco 6015 system modules.



Caution

Any module that is only partially connected to the backplane can disrupt system operation.

- Do not force the module into its slot. This action can damage the pins on the backplane if they are not aligned properly with the module.
- Ensure that the module is straight and not at an angle when you install the module in the slot. Installing the module at an angle can damage the module. Use the guide rails to install the module correctly.

Hot Swapping Modules

Hot swapping allows you to remove and replace the module without disconnecting the system power. The Cisco 6015 chassis supports hot swapping for the fan module. Hot swapping the fan module will not interrupt the service for any subscribers.

Preventing Electrostatic Discharge Damage

Proper ESD protection is required whenever you handle Cisco equipment. ESD damage, which can occur when electronic cards or components are improperly handled, results in complete or intermittent failures. Use an antistatic strap when you handle any card or component.

There is an ESD grounding jack that is located on the fan module, as shown in [Figure 3](#).

**Tip**

Use the ESD grounding jack on the fan module for all maintenance except when you are removing the fan module. Use the ESD grounding jack on the DC PEM when you are removing the fan module.

Follow these guidelines to prevent ESD damage:

- Always use an ESD ankle or wrist strap and ensure that the wrist strap makes good skin contact.
- Connect the equipment end of the strap to the ESD grounding jack. There are two ESD grounding jacks that are located on the following Cisco 6015 chassis modules:
 - Fan module
 - DC PEM
- When you install a component, use available ejector levers or captive installation screws to properly seat the bus connectors in the backplane or midplane. These devices prevent accidental removal, provide proper grounding for the system, and help ensure that bus connectors are properly seated.
- When you remove a component, use available ejector levers or captive installation screws to release the bus connectors from the backplane or midplane.
- Handle the modules by the extraction handles only; avoid touching the printed circuit boards or connectors.
- Place a removed component board-side-up on an antistatic surface or in a static-shielding container. If you plan to return the component to the factory, immediately place it in a static-shielding container.
- Avoid contact between the printed circuit boards and clothing. The wrist strap protects components from ESD voltages on the body only; ESD voltages on clothing can still cause damage.

**Caution**

Periodically check the resistance value of the antistatic strap. Ensure that the measurement is between 1 and 10 megohms.

Removing and Installing the Fan Module

The following sections describe how to remove or install a fan module.



Proper ESD protection is required whenever you handle Cisco equipment. Installation and maintenance personnel should be properly grounded by means of grounding straps to eliminate the risk of ESD damage to the equipment. Equipment is subject to ESD damage whenever it is removed from the chassis.

Removing the Fan Module

Complete the following steps to remove the fan module from the Cisco 6015 chassis:

-
- Step 1** Connect a grounding strap to the ESD grounding jack that is located on the DC PEM.
 - Step 2** Use a flat-head or Phillips-head screwdriver to unscrew the two screws that hold the fan module to the Cisco 6015 chassis.
 - Step 3** Hold the extraction handle on the right side of the module and carefully slide the module out of the slot. See the [“Installing the Fan Module” section on page 12](#) for fan module installation procedures.
-

Installing the Fan Module

Complete the following steps to install the fan module in the Cisco 6015 chassis:

-
- Step 1** Connect a grounding strap to the ESD grounding jack that is located on the DC PEM.
 - Step 2** Vertically align the module edges with the module guides at the top and bottom of the slot in the Cisco 6015.

Figure 5 shows the fan module installation.

Figure 5 Fan Module Installation in the Cisco 6015

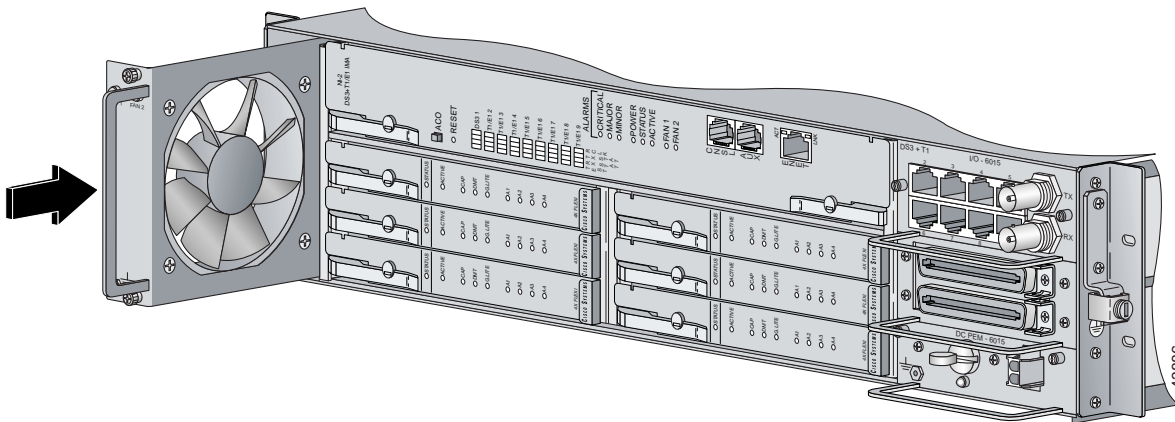

- Step 3** Hold the extraction handle on the right side of the module and gently apply pressure while pushing the module into the slot.
- Step 4** Push on the faceplate of the module to fully seat the module.
- Step 5** Align the two screws that are located at the top and bottom of the module with the screw holes in the Cisco 6015 chassis.
- Step 6** Use a flat-head or Phillips-head screwdriver to tighten the screws to secure the fan module.
- Step 7** Verify that the LEDs on the fan module are solid green once the module is installed and secured. If the LEDs are not green, refer to the *Cisco 6015 Hardware Installation Guide* for troubleshooting procedures.

Standards and Certifications

The fan module has the same standards as the Cisco 6015 system, as shown in [Table 3](#).

Table 3 Regulatory Compliance for Cisco 6015 Hardware

Area of Compliance	Compliance Standard
Product Safety	UL 1950, 3rd Edition, EN 60950, AS/NZS 3260, IEC 950, FCC Part 15, Class B
Emissions	CISPR22, EN55022, AS/ANS 3548, ICES-003, VCCI, BSMI (CNS 13438)
Immunity	EN61000-4-2, 3, 4, 5 and 6 / IEC-61000-4-2, 3, 4, 5 and 6; EN61000-4-11 / IEC-61000-4-11
NEBS	Bellcore GR-63-CORE, GR-1089-CORE, SR-3590 Level 3
Telecom	FCC Part 68, CS-03, ACA TS 016: 1997, CTR 12 97/520/EC Amendment 1 1997 (TBR 12), JATE GREEN BOOK 1997
ETSI	300-386-1, 300-386-2, 300-019

Related Documentation

A complete list of all DSL product related documentation is available on the World Wide Web at http://www.cisco.com/univercd/cc/td/doc/product/dsl_prod/index.htm

Obtaining Documentation

The following sections explain how to obtain documentation from Cisco Systems.

World Wide Web

You can access the most current Cisco documentation on the World Wide Web at the following URL:

<http://www.cisco.com>

Translated documentation is available at the following URL:

http://www.cisco.com/public/countries_languages.shtml

Documentation CD-ROM

Cisco documentation and additional literature are available in a Cisco Documentation CD-ROM package, which is shipped with your product. The Documentation CD-ROM is updated monthly and may be more current than printed documentation. The CD-ROM package is available as a single unit or through an annual subscription. Registered Cisco.com users can order the Documentation CD-ROM through the online Subscription Store:

<http://www.cisco.com/go/subscription>

Documentation Feedback

If you are reading Cisco product documentation on Cisco.com, you can submit technical comments electronically. Click **Leave Feedback** at the bottom of the Cisco Documentation home page. After you complete the form, print it out and fax it to Cisco at 408 527-0730.

You can e-mail your comments to bug-doc@cisco.com.

To submit your comments by mail, use the response card behind the front cover of your document, or write to the following address:

Cisco Systems
Attn: Document Resource Connection
170 West Tasman Drive
San Jose, CA 95134-9883

We appreciate your comments.

Obtaining Technical Assistance

Cisco provides Cisco.com as a starting point for all technical assistance. Customers and partners can obtain documentation, troubleshooting tips, and sample configurations from online tools by using the Cisco Technical Assistance Center (TAC) Web Site. Cisco.com registered users have complete access to the technical support resources on the Cisco TAC Web Site.

Cisco.com

Cisco.com is the foundation of a suite of interactive, networked services that provides immediate, open access to Cisco information, networking solutions, services, programs, and resources at any time, from anywhere in the world.

Cisco.com is a highly integrated Internet application and a powerful, easy-to-use tool that provides a broad range of features and services to help you to

- Streamline business processes and improve productivity
- Resolve technical issues with online support
- Download and test software packages
- Order Cisco learning materials and merchandise
- Register for online skill assessment, training, and certification programs

You can self-register on Cisco.com to obtain customized information and service. To access Cisco.com, go to the following URL:

<http://www.cisco.com>

Technical Assistance Center

The Cisco TAC is available to all customers who need technical assistance with a Cisco product, technology, or solution. Two types of support are available through the Cisco TAC: the Cisco TAC Web Site and the Cisco TAC Escalation Center.

Inquiries to Cisco TAC are categorized according to the urgency of the issue:

- Priority level 4 (P4)—You need information or assistance concerning Cisco product capabilities, product installation, or basic product configuration.
- Priority level 3 (P3)—Your network performance is degraded. Network functionality is noticeably impaired, but most business operations continue.
- Priority level 2 (P2)—Your production network is severely degraded, affecting significant aspects of business operations. No workaround is available.
- Priority level 1 (P1)—Your production network is down, and a critical impact to business operations will occur if service is not restored quickly. No workaround is available.

Which Cisco TAC resource you choose is based on the priority of the problem and the conditions of service contracts, when applicable.

Cisco TAC Web Site

The Cisco TAC Web Site allows you to resolve P3 and P4 issues yourself, saving both cost and time. The site provides around-the-clock access to online tools, knowledge bases, and software. To access the Cisco TAC Web Site, go to the following URL:

<http://www.cisco.com/tac>

All customers, partners, and resellers who have a valid Cisco services contract have complete access to the technical support resources on the Cisco TAC Web Site. The Cisco TAC Web Site requires a Cisco.com login ID and password. If you have a valid service contract but do not have a login ID or password, go to the following URL to register:

<http://www.cisco.com/register/>

If you cannot resolve your technical issues by using the Cisco TAC Web Site, and you are a Cisco.com registered user, you can open a case online by using the TAC Case Open tool at the following URL:

<http://www.cisco.com/tac/caseopen>

If you have Internet access, it is recommended that you open P3 and P4 cases through the Cisco TAC Web Site.

Cisco TAC Escalation Center

The Cisco TAC Escalation Center addresses issues that are classified as priority level 1 or priority level 2; these classifications are assigned when severe network degradation significantly impacts business operations. When you contact the TAC Escalation Center with a P1 or P2 problem, a Cisco TAC engineer will automatically open a case.

To obtain a directory of toll-free Cisco TAC telephone numbers for your country, go to the following URL:

<http://www.cisco.com/warp/public/687/Directory/DirTAC.shtml>

Before calling, please check with your network operations center to determine the level of Cisco support services to which your company is entitled; for example, SMARTnet, SMARTnet Onsite, or Network Supported Accounts (NSA). In addition, please have available your service agreement number and your product serial number.

This document is to be used in conjunction with the documents listed in the “[Related Documentation](#)” section.

CCIP, the Cisco Arrow logo, the Cisco *Powered* Network mark, the Cisco Systems Verified logo, Cisco Unity, Follow Me Browsing, FormShare, Internet Quotient, iQ Breakthrough, iQ Expertise, iQ FastTrack, the iQ Logo, iQ Net Readiness Scorecard, Networking Academy, ScriptShare, SMARTnet, TransPath, and Voice LAN are trademarks of Cisco Systems, Inc.; Changing the Way We Work, Live, Play, and Learn, Discover All That’s Possible, The Fastest Way to Increase Your Internet Quotient, and iQuick Study are service marks of Cisco Systems, Inc.; and Aironet, ASIST, BPX, Catalyst, CCDA, CCDP, CCIE, CCNA, CCNP, Cisco, the Cisco Certified Internetwork Expert logo, Cisco IOS, the Cisco IOS logo, Cisco Press, Cisco Systems, Cisco Systems Capital, the Cisco Systems logo, Empowering the Internet Generation, Enterprise/Solver, EtherChannel, EtherSwitch, Fast Step, GigaStack, IOS, IP/TV, LightStream, MGX, MICA, the Networkers logo, Network Registrar, *Packet*, PIX, Post-Routing, Pre-Routing, RateMUX, Registrar, SlideCast, StrataView Plus, Stratm, SwitchProbe, TeleRouter, and VCO are registered trademarks of Cisco Systems, Inc. and/or its affiliates in the U.S. and certain other countries.

All other trademarks mentioned in this document or Web site are the property of their respective owners. The use of the word partner does not imply a partnership relationship between Cisco and any other company. (0206R)

Copyright © 2002, Cisco Systems, Inc.
All rights reserved.